

FG085 miniDDS Function Generator

Manual of Operation

Applicable Models: 08501, 08501K, 08502K, 08503, 08503K, 08504K

Applicable Firmware Version: 1) 113-08501-130 or later (for U5)

2) 113-08502-050 or later (for U6)

1.	Getting Started	1
2.	Front Panel Features	2
3.	Connectors	4
4.	FG085 Operations.....	6
	Continuous Waveform (CW) Mode.....	6
	Frequency	7
	Amplitude.....	8
	DC Offset.....	8
	Incremental Adjustment.....	8
	Duty Cycle.....	8
	Trigger Function	9
	Frequency Sweeping Mode	9
	Range and Rate.....	11
	Sweep Direction	12
	Trigger Function	12
	Sync Pulse Output	12
	Amplitude.....	12
	DC Offset.....	12
	Servo Position Mode	13
	Pulse Width and.....	14
	Pulse Amplitude.....	14
	Increment and	14
	Servo Signal Settings.....	15
	Servo Run Mode.....	15
	States	16
	Change Settings	16
	Arbitrary Waveform Generation (AWG)	16
	How It works	16
	Define Waveform File	17
	Download Waveform.....	17
	Select User Waveform	17
	Waveform Download.....	18
5.	Firmware Upgrade	18
6.	Technical Support	19
7.	Specifications.....	19
	Revision History.....	20

1. Getting Started

Introduction

The FG085 is a low cost versatile function generator capable of producing continuous signal, frequency sweeping signal, servo test signal, and user defined arbitrary signals. It was designed as an easy-to-use tool for electronic hobbyists. The operation of FG085 is extremely straightforward. The following examples will lead you step-by-step through some typical uses.

Data Entry

Setting of FG085 signal parameters is done by first pressing one of the parameter keys (F/T, AMP, or OFS). The display of that parameter will be cleared and an underline is shown, indicating place for new value to be typed in. If at the moment you hit a parameter key the cursor is not currently at that parameter just press the key one more time to make the underline shown. Then enter new value using the DIGIT keys. Complete entry by hitting one of the UNITS keys. If an error is made at typing pressing [ESC] key will do backspace to correct it. If no more digits left when [ESC] is pressed it will exit Data Entry and display the original value.

A cursor focused parameter can also be adjusted incrementally by tuning [ADJ] dial.

Examples

1) To set output frequency to 5KHz press the following keys:

[F/T] [5] [KHz]

2) To change output waveform to square wave press [WF] until "SQR" is shown.

3) To set output amplitude to 3V peak-to-peak press the following keys:

[AMP] [3] [V]

4) To set DC offset to -2.5V press the following keys

[OFS] [+/-] [2] [.] [5] [V]

2. Front Panel Features

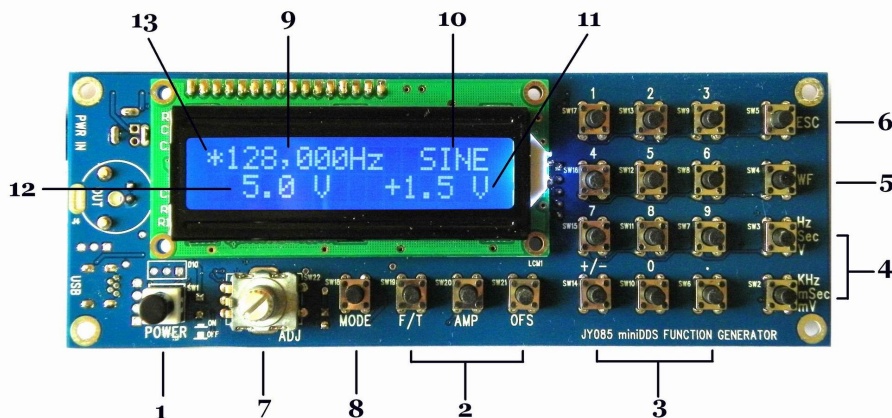

Front view of 08501/08502

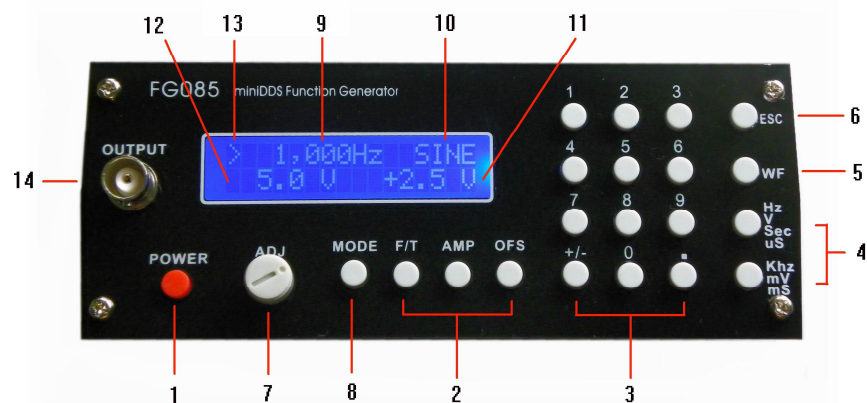

Front view of 08503

- 1) **Power Switch** The power switch turns the FG085 on and off.
- 2) **Parameter Keys** The parameter keys select the parameter to be entered. If cursor is not currently at a parameter pressing the parameter key will first move cursor to that parameter.
- 3) **Digit Keys** The numeric keypad allows for direct entry of the FG085's parameters. To change a parameter value simply press the parameter key (if cursor is not currently at the parameter press the parameter key twice) and then type a new value. Entries are terminated by the UNITS keys. If an error is made at typing press [ESC] key to correct it (back space). If no more digits left when [ESC] is pressed it will exit Data Entry and display the previous value.

The [+/-] key may be pressed at any time during numeric entry.
- 4) **Unit Keys** The UNIT keys are used to terminate numeric entries. Note that the unit keys represent different unit at different parameter entry.
Under CW mode pressing unit keys without first entering digits will display incremental step sizes. [Hz] key displays frequency step size. [KHz] key displays time step size.
- 5) **Waveform Key** This key selects output waveform. Repeated pressing of this key will go through all available waveforms.
- 6) **ESC key** This key backspace typed digits and/or exit current state.
- 7) **ADJ Dial** By [ADJ] dial users can incrementally adjust a focused parameter up and down. To do this first pressing a parameter key to move cursor the parameter to be changed and then turn the dial.

Under CW or Sweep mode pressing the dial will toggle Trigger function on or off.

At Servo mode pressing the dial will enter **Setting Change**

state

- 8) **MODE Key** This key selects FG085's working modes.
- 9) **Frequency (Period)** Display of current output frequency or period.
- 10) **Waveform** Display of current waveform type.
- 11) **DC Offset** Display of current output DC offset.
- 12) **Amplitude** Display of current output amplitude.
- 13) **Cursor** Indication of currently focused parameter. Turning [ADJ] dial will incrementally change this parameter. When Trigger Function is on the cursor change to '*'.
- 14) **Function Output (J4)** This is the front output connector. Its output impedance is 50Ω.

3. Connectors

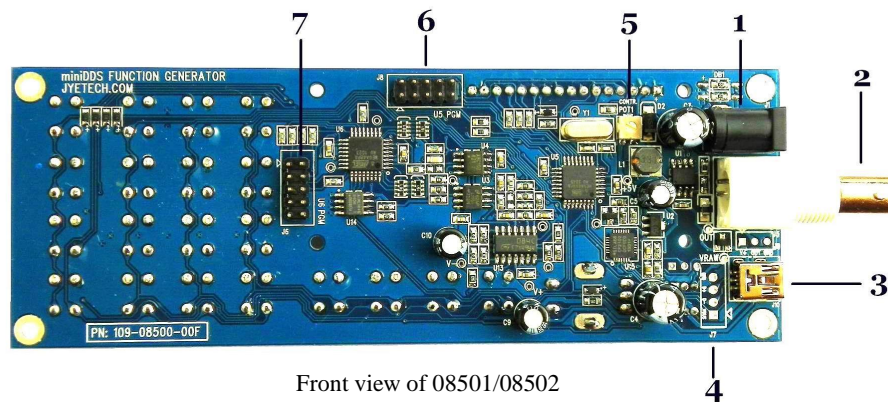

Front view of 08501/08502

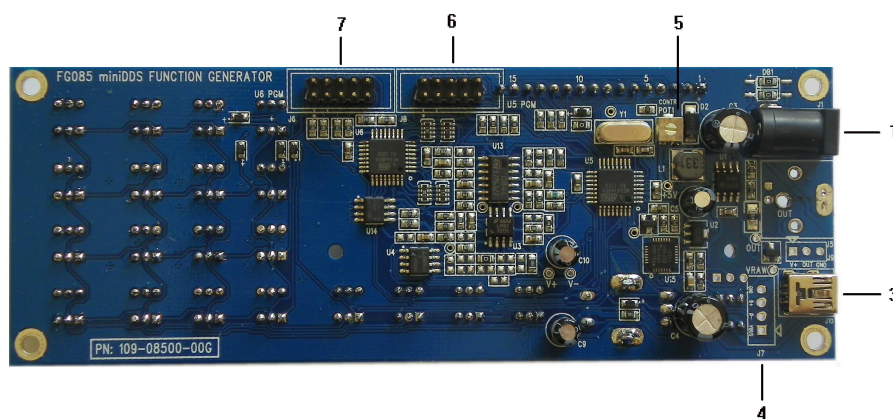

Board view of 08503

- 1) Power Input (J1)** This is the DC power supply input connector. Its center core should be connected to the positive pole of power supply. FG085 is specified for 14V – 16V DC. The current capacity of power supply should be greater than 200mA average.
- 2) Function Output (J5)** This is the back output connector. Its output impedance is 50Ω.
- 3) USB (J10)** This provides a connection to PC for waveform data download and instrument control.
- 4) Alternative USB (J7)** This connector allows wiring the USB connection to socket at enclosure.
- 5) Contrast Adjustment** This is a trimmer for LCD contrast adjustment.
- 6) U5 Programming Port (J8)** This is the programming header for the main controller ATmega168 (U5).

Pin-out Description

Pin#	Signal Name	I/O	Function
1	MOSI	I	U5 programming
2	+5V	PWR	
3	NC	-	No connection
4	-	-	Reserved
5	nRST	I	U5 programming
6	-	-	Reserved
7	SCK	I	U5 programming
8	GND	PWR	
9	MISO	O	U5 programming
10	GND	PWR	

- 7) U6 Programming Port (J6)** This is the programming header for the DDS core controller ATmega48 (U6)

Pin-out Description

Pin#	Signal Name	I/O	Function
1	MOSI	I	U6 programming
2	+5V	PWR	
3	Sync	O	Sync output (sweeping mode)
4	-	-	Reserved
5	nRST	I	U6 programming
6	TrigIn	I	Trigger input
7	SCK	I	U6 programming
8	GND	PWR	
9	MISO	O	U6 programming
10	GND	PWR	

4. FG085 Operations

Power-on Push down the power switch to turn on FG085. It will first display model name. Then manufacturer/vendor name follows. After displaying firmware versions the unit enters normal working state.

Output The output amplitude display is only correct when load is in high impedance (much larger than 50Ω). If load impedance is close to 50Ω the output amplitude will be lower than displayed. If load impedance is 50Ω the output amplitude will half of that displayed.

Mode Selection FG085 can work in one of four different modes. These four modes are:

- 1) Continuous Waveforms (CW) mode
- 2) Frequency Sweeping mode
- 3) Servo Position mode
- 4) Servo Run mode

Pressing [Mode] button will display the mode selection menu.



Tuning [ADJ] will scroll through these modes. The number at the lower-right corner indicates menu position. Pressing [MODE] will select the mode displayed. Pressing [ESC] will exit mode selection without change.

Continuous Waveform (CW) Mode

In this mode the generator outputs continuous signal of selected waveforms. Signal frequency, amplitude, and DC offset can be independently set by user.

Screen Please refer to Section 2 “Front Panel Features”.

Waveform Selection Waveform selection is done by pressing [WF] key.

Frequency

Frequency is set by first pressing [F/T]. The current display will be erased and an underline is shown, allowing user to enter new value. New value is entered with digit keys and followed by one of the Unit keys. Alternatively, frequency can be changed incrementally by using the [ADJ] dial when it is focused. The incremental step size can be set to any number you want (see below).

Frequency can also be set in period (indicated by letter 'T'). Press [F/T] key will toggle between frequency and period entry mode.

Frequency Range

In spite of that no limited range is set for frequency entry it should be aware of that there are practical ranges for output frequency due to the low resolution 8-bit DAC and slow sample rate (2.5Msps). Out of these ranges signal quality will be degraded as larger distortions and jitters appear. The acceptable ranges depend on actual applications. For FG085 output frequency within the following range is considered reasonably good for most applications.

Function	Range
Sine	0 – 200KHz
Square	0 – 10KHz
Triangle	0 – 10KHz
Ramp	0 – 10KHz
Staircase	0 – 10KHz

Maximum Frequency Error

Maximum frequency error depends on sample clock and phase accumulator size. For FG085 the phase accumulator size is 24 bits. Two sampling clocks, 2.5Msps and 10Ksps, are used. Sample clock is automatically selected based on frequency setting as shown in the table below.

Frequency	Sampling Clock	Maximum Error
> 40Hz	2.5Msps	0.1490 Hz
≅ 40Hz	10Ksps	0.0005960 Hz

Amplitude	<p>Amplitude is set by first pressing [AMP] key. The current display will be erased and an underline is shown, allowing user to enter new value. New value is entered with Data Entry keys and followed by one of the Unit keys. Alternatively, amplitude can be changed incrementally by using the rotary encoder when it is focused.</p> <p>The displayed amplitude value is peak-to-peak value.</p> <p>The amplitude range is limited by the DC offset setting since $V_{ac\ peak} + V_{dc} \leq 10\ V$ (into High-Z).</p> <p>D.C. Only</p> <p>The output of the FG085 can be set to a DC level by entering amplitude of 0V. When the amplitude is set to zero the A.C. waveform will be completely shut off and the FG085 may be used as a DC voltage source.</p>
DC Offset	<p>DC offset can be set by first pressing [OFS] key. The current display will be erased and an underline is shown, allowing user to enter new value. New value is entered with Data Entry keys and followed by one of the Unit keys. Alternatively, offset can be changed incrementally by tuning [ADJ] when it is focused.</p> <p>In general, the DC offset may range between $\pm 5V$, but it is limited such that $V_{ac\ peak} + V_{dc} \leq 10\ V$ (into High-Z), or $V_{ac\ peak} + V_{dc} \leq 10\ V$ (into HIGH-Z).</p>
Incremental Adjustment	<p>FG085's output frequency, amplitude, and DC offset can be changed incrementally up and down by using [ADJ] dial. To do this first move cursor to the parameter you want to change by pressing a parameter key and then turn the rotary encoder clock-wise for increment and counter-clock-wise for decrement.</p> <p>Tip</p> <p><i>Incremental step size can be set to any value. To do this directly enter the step size you want and follow by [Hz] or [ms] button. [Hz] button sets step size for frequency adjustment. [ms] button sets step size for time adjustment. Press [Hz] or [ms] without digits will display current frequency or time step size.</i></p>
Duty Cycle (for square waveform)	<p>Duty cycle can be set to value between 0% and 100%. Pressing [.] (the decimal point key) will display current duty cycle. Press [.] key again the display will be erased and an underline will show, allowing user to enter new value. Pressing any of the unit keys terminates the entry. Pressing [ESC] returns to normal CW mode display.</p> <p>Note that duty cycle only takes effect for square waveform. The acceptable value range is 0 – 100% with resolution of 1%.</p>

Trigger Function

The trigger function allows user to control the generator output by an external signal. When the external signal is HIGH output signal is stopped. As soon as the trigger signal changes to LOW output signal resumes (see screen capture below).

The external signal must be TTL level compatible and applied to pin 6 of J6.

The trigger function can be turned on/off by pressing [ADJ] dial. When it is on the cursor (normally '>') will change to '*>' as indicator.

The initial phase of output signal at each trigger is constant.

Note that the trigger input is pulled to HIGH internally. There will be no output when the terminal is left open. This feature allows using a switch as trigger source.

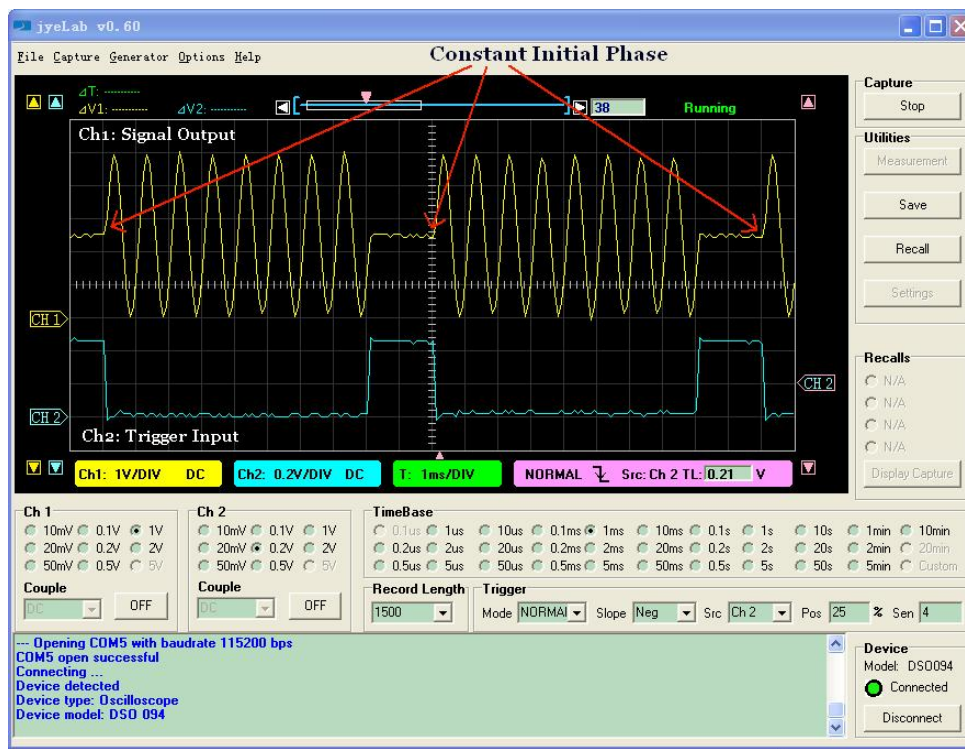

Trigger waveform

Frequency Sweeping Mode

In this mode FG085 generate frequency sweeping signals. The sweeping range and rate as well as signal amplitude and DC offset are all independently set by user.

Screen

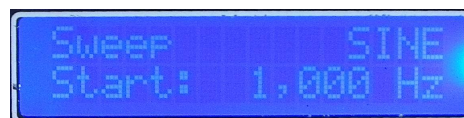

Turning [ADJ] or pressing digit buttons [1], [2], [3], and [4] will have Start Freq, Stop Freq, Sweep Time, and Time Step Size displayed respectively.

Waveform Selection Waveform selection is done by pressing [WF] key.



Normal sweeping

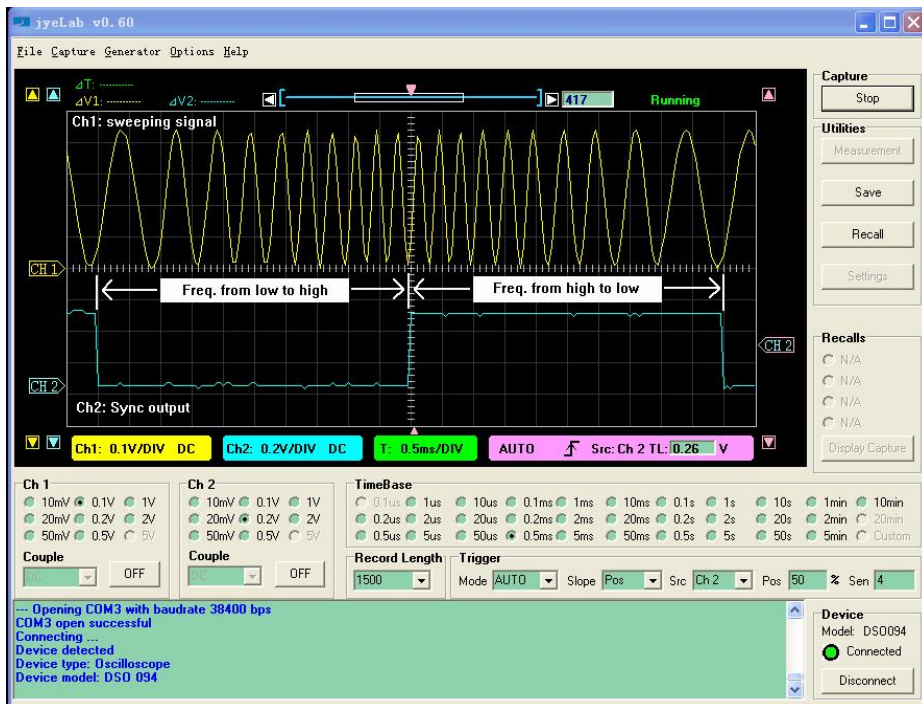

Bi-directional sweeping

Range and Rate of Sweep

Frequency sweeping is actually frequency stepping. Four parameters determine the frequency change range and rate:

- Start Frequency
- Stop Frequency
- Sweep Time
- Time Step Size

The following drawing illustrates their relationships. Frequency change is linear only. The smallest time step is 1ms.

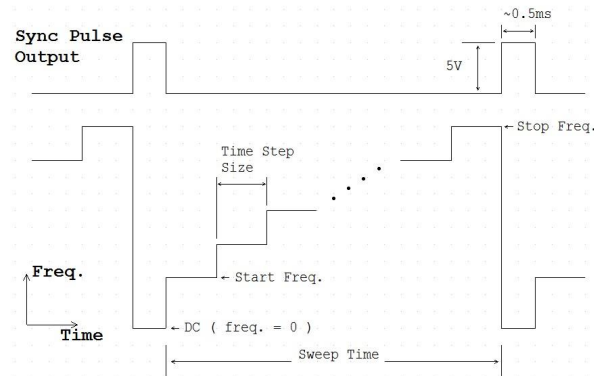

To change these parameters first turn [ADJ] dial to select the parameter you want to change. Then press [F/T] button to enter values.

Tip

You can also quickly access these parameters by buttons [1], [2], [3], and [4]. Their relationships are:

- [1] - Select/change Start Frequency
- [2] - Select/change Stop Frequency
- [3] - Select/change Sweep Time
- [4] - Select/change Time Step Size

Notes:

1. Start and stop frequencies can only be entered in Hz or KHz. The DDS sampling clock selects 2.5MSPs as long as sweeping mode is entered. As a result the frequency resolution in this mode is 0.1490Hz (see explanations in CW mode). The allowable frequency range is 0 – 999999 Hz. Keep in mind that when frequency goes beyond certain extend the signal quality degrades significantly.
2. Sweep time can be entered in Sec or mSec. It is always displayed in "mS". The allowable sweep time range is 1 – 999999 mS.
3. Time step size can be entered in Sec or mSec. It is always displayed in "mS". The allowed range is 1 – 65535 mS.
4. When Sweep Time is less than Time Step Size the actual sweep time becomes 2 * (Time Step Size). Frequency sweeping in this case is degraded to outputting start and stop frequency alternatively. This creates an effect of FSK.

Sweep Direction	<p>Normally frequency sweeping is from start frequency (Fstart) to stop frequency (Fstop). This is called Normal Sweeping. For FG085 the sweep can be set to two way sweeping, i.e. it sweeps from Fstart to Fstop, and then from Fstop back to Fstart. This is call Bi-directional sweeping.</p> <p>To enable bi-directional sweeping press the [+/-] button. A letter 'B' will be shown on screen, indicating bi-directional sweep is enabled. Press [+/-] again will turn the function off.</p> <p>See photos above for normal sweeping and bi-directional sweeping.</p> <p>For bi-directional sweeping the signal phase is continuous every where.</p>
Trigger Function	<p>Trigger function is also available for sweep mode. When this function is enabled the generator only starts sweeping at falling edge of trigger signal.</p> <p>Press [ADJ] to toggle trigger function on/off. A '*' character will be displayed on screen to indicate trigger function is on.</p> <p>Unlike the case in CW mode where output stops as soon as trigger signal changes to HIGH, sweeping signal will finish a full sweep even trigger signal has turned HIGH before the end of a started sweep.</p>
Sync Pulse Output	<p>For normal sweeping a positive synchronous pulse is generated at pin 3 of J6 between the end of a sweep and the start of next sweep. The pulse width is about 0.5ms. Its amplitude is 5V. See the photo of normal sweeping above.</p> <p>For bi-directional sweeping the same pin outputs LOW (0V) level when sweeping from Fstart to Fstop and outputs HIGH (+5V) level when sweeping the other way around (i.e. from Fstop to Fstart, see the photo of bi-directional sweeping above).</p>
Amplitude	<p>See the explanation of "Amplitude" in CW mode.</p>
DC Offset	<p>See the explanation of "DC Offset" in CW mode.</p>

Servo Position Mode

In this mode the generator outputs servo control signal with specific pulse width, amplitude, and cycle. All these parameters can be set independently by user.

Servo Control Signal The drawing below shows a servo control signal.

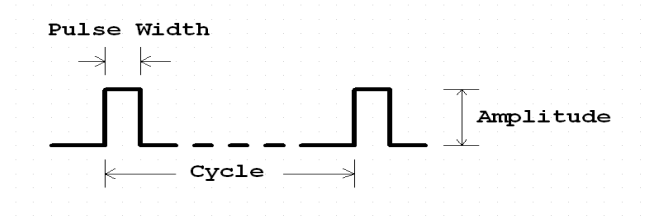

Typically servo signal takes following parameters:

- 1) Cycle: 20ms
- 2) Pulse Width: 1ms – 2ms
- 3) Pulse Amplitude: 5V

The pulse width determines servo position.

Screens

The photo below shows the screens of Servo Position Mode. The first screen shows pulse width in unit of microsecond. The second shows pulse amplitude in unit of volt. Pressing [F/T] will display the pulse width screen and pressing [AMP] will display the amplitude screen.



Pulse Width and Cycle

At pulse width screen pressing [F/T] will erase current display and show an underline, allowing user to enter new pulse width. New pulse width is entered with Data Entry keys and followed by one of the two Unit keys. The value entered is treated as **microsecond** if the unit key [Sec] is used, or as **millisecond** if the unit key [mSec] is used.

Please note that the range of pulse width that user can actually enter is limited by two values, SV.PWmin and SV.PWmax. If the pulse width you input is out of the range defined by SV.PWmin and SV.PWmax then the input will be substituted by the limit numbers. These limiting values can be modified by user (see below). The default values of SV.PWmin and SV.PWmax are 1000 uSec and 2000 uSec respectively.

Servo **signal cycle** can be changed too. This is done by modifying the setting SV.Cycle in Setting Change state (see below).

Pulse Amplitude

At pulse amplitude screen pressing [AMP] will erase current display and show an underline, allowing you to enter new pulse amplitude. Enter new pulse amplitude with Data Entry keys and follow by one of the two Unit keys. The number you entered is treated as **volt** if the unit key [V] is used, or as **mill volt** if the unit key [mV] is used.

Like pulse width the maximum of amplitude that user can enter is limited by the value of SV.AMPmax. If the amplitude entered is greater than SV.AMPmax then the input will be substituted by SV.AMPmax. The default value of SV.AMPmax is 5.0V. It can also be changed in "Change Setting" state (see below).

Increment and Decrement

At either pulse width screen or amplitude screen user can turn [ADJ] to incrementally change pulse width or amplitude. The step size of incremental change for pulse width is defined by SV.PWinc, another setting that can be modified by user (see below).

Servo Signal Settings

Servo signal settings are a number of EEPROM stored values that affect the behaviour of servo signal generation. These values are user changeable. In order to change these values pressing [ADJ] to enter **Setting Change** state. The following screen will be displayed.



The top line shows a setting name. The bottom line shows its value. The number at top-right corner indicates current menu position.

To change a setting first scroll to that setting by turning [ADJ]. Then press [F/T] to enter a new value.

Pressing [ESC] will exit Setting Change state.

Restore factory default

Factory default settings can be restored by scroll to the last item and pressing [WF] key.

The following table lists the details about servo signal settings.

Setting	Descriptions	Acceptable Range	Default
SV.PWmin	The minimum pulse width allowed	0 – 26000 uSec	1000
SV.PWmax	The maximum pulse width allowed	0 – 26000 uSec	2000
SV.PWmid	Pulse width corresponding to servo nuture position	0 – 26000 uSec	1500
SV.PWinc	[ADJ] step size in Servo Pos mode	0 – 26000 uSec	100
SV.RunStep	Step size of pulse width change in Servo Run mode	0 – 26000 uSec	100
SV.RunRate	Duration of one step in Servo Run mode	0 – 6.5 Second	0.1
SV.Cycle	Servo signal cycle	0 – 26000 uSec	20000
SV.AMPmax	The maximum pulse amplitude allowed	0 – 10.0V	5.0V

When a setting is set to a value out of acceptable range the instrument behaviour is not defined.

Servo Run Mode

In this mode the generator outputs servo control signal with changing pulse width. The pulse width change step, rate, and range are user settable.

States

When Servo Run mode is first entered it stays at **Ready** state.



In this state a constant signal with pulse width equal to SV.PWmin is generated.

When [WF] button is pressed it transfers to **Running** state.



In this state pulse width will change from SV.PWmin to SV.PWmax incrementally in step defined by SV.RunStep. Once it reaches SV.PWmax it will immediately change in the reverse direction, i.e. from SV.PWmax to SV.PWmin incrementally with the same step size. Pulse width will vary in this way until [WF] key is pressed.

When [WF] key is pressed in Running state the generator will enter **Hold** state, where pulse width changing stops and maintains the value at the moment [WF] key is pressed.

**Change Settings**

Settings that affect Servo Run mode behaviour include SV.PWmin, SV.PWmax, SV.RunStep, and SV.RunRate. These settings can be changed by user. Please refer to paragraph titled "Servo Signal Settings" above for details.

Arbitrary Waveform Generation (AWG)

With firmware version 113-08501-130 (for U5) and 113-08502-050 (for U6) FG085 is capable of generating arbitrary waveforms defined by user.

How It works

FG085 has an EEPROM user waveform buffer in U5. When waveform type "USER" is selected the data in this buffer will be loaded to DDS core (U6). The user waveform buffer is writable by PC software through USB.

In order to generate user defined waveform three steps are required:

- 1) Define a waveform file
- 2) Download the waveform file to user waveform buffer
- 3) Select the waveform and adjust parameters

Define Waveform File The user waveform buffer consists of 256 samples with each sample being 8 bits. A waveform file defines the value of each sample in the buffer. The waveform file is in general CSV (comma separated value) format, which can be opened and edited by many spreadsheet applications and text editors. A waveform template file has been provided at JYE Tech web site. Based on the template users can use any text editor to create their own waveform files easily and quickly. For detailed descriptions of the internal format of FG085 waveform file please refer to the article “FG085 Waveform File Format”.

Download Waveform To FG085 Waveform is downloaded to FG085 by the jyeLab application (see <http://www.jyetechnology.com/Products/105/e105.php>). To do this:

- 1) Launch jyeLab. Connect FG085 to PC via USB and click the “Connect” button to establish connection. Make sure correct COM port and baudrate are selected.
- 2) Open the waveform file you have prepared.
- 3) Select menu “Generator -> Download”.

Please refer to the article “How To Generate User Defined Waveform” (available at <http://www.jyetechnology.com>).

Select User Waveform Press [WF] button until “USER” is displayed.

Waveform Download Protocol

The waveform download follows a simple protocol which is explained below.

- 1) **Serial format** Baudrate is fixed at 115200 bps. Data format is 8-N-1. No flow control.
- 2) **Frame structure** (multi-byte fields are all little endian)

Offset	Field Name(size)	Value
-1	Sync character (1 byte)	0xFE
0	Command (1 byte) (write waveform)	0x14
1	Frame Size (2 bytes)	Count from the command byte to the end of waveform data.
3	Reserved (1 byte)	0x00
4	Data Size (2 bytes)	Number of bytes to be downloaded to FG085 (usually should be 256. If it is greater than 256 the extra data will be ignored.)
6	Reserved (8 byte)	0x00
14	[waveform data] (as specified in Data Size field)	Data start

- 3) **Special value [0xFE]** Hexical value 0xFE serves as synchronous character in the waveform download. It must be unique to ensure correct transmission/receiving. So if another 0xFE presents in the fields of frame size, data size, or waveform data a 0x00 byte must be inserted right after it at transmission.

5. Firmware Upgrade

From time to time there may be a need to upgrade firmwares in order to add features or improve performance. FG085 contains two AVR micro-controllers from Atmel:

- 1) ATmega168PA (U5), which is the main controller of the instrument.
- 2) ATmega48PA (U6), which is the DDS core.

To upgrade firmware an AVR programmer with compatible programming header is required. For programming header pin-out please refer to tables under section “**Connectors**”. If the programming header you have has a different pin-out. You need to re-route the signals to make them match. **(JYE Tech’s USB AVR Programmer [PN: 07302] is ideal for FG085 programming. Please visit www.jyetechnology.com for details.)**

Download updated firmware files from JYE Tech website (www.jyetechnology.com) and follow

instructions of the programmer you have to carry out firmware upgrading.

About Fuse Bits

AVR micro-controllers contain some fuse bits that configure the chip for specific applications. In most cases these fuse bits should not be touched at firmware upgrading. But if somehow these bits are changed they should be restored as follows.

- 1) ATmega168PA (U5)
 - Extended Fuse Byte: **0b00000111** (**0x07**)
 - High Fuse Byte: **0b11010110** (**0xD6**)
 - Low Fuse Byte: **0b11100110** (**0xE6**)
- 2) ATmega48PA (U6), which is the DDS core.
 - Extended Fuse Byte: **0b00000001** (**0x01**)
 - High Fuse Byte: **0b11010110** (**0xD6**)
 - Low Fuse Byte: **0b11100000** (**0xE0**)

6. Technical Support

For any technical issues or questions in using the instrument please contact JYE Tech at support@jyetechnology.com. Or post your questions at JYE Tech forum at <http://forum.jyetechnology.com>.

7. Specifications

Frequency Range	0 – 200KHz (Sine) 0 – 10K (all other waveforms)
Frequency Resolution	1Hz
Period Resolution	1ms
Maximum Frequency Error	CW Mode: 0.1490 Hz when frequency > 40 Hz (2.5Msps clock) 0.0005960 Hz when frequency \leq 40Hz (10Ksps clock) Sweeping Mode: 0.1490 Hz when frequency > 40 Hz (2.5Msps clock)
Amplitude Range	0 – 10V peak-to-peak (when power supply voltage > 13V)
Amplitude Resolution	0.1V
DC Offset Range	-5V – +5V
Offset Resolution	40mV
Sample Rate	CW Mode: 2.5Msps when frequency > 40Hz 10Ksps clock when frequency \leq 40Hz Sweeping Mode: 2.5Msps
Waveform Buffer Size	256 bytes
Sample Resolution	8-bits
Trigger Input Level	High: 3.5V minimum Low: 1.5V maximum
Output Delay at Trigger	5 μ s maximum (when no panel operation)
Sync Output Level	High: 4.5V minimum at 10K resistance load Low: 0.7V maximum at 10mA intake current

Output Impedance	50 ohm
Power Supply	14V DC (maximum 16V DC)
Current Consumption	< 150mA (without loading)
Circuit Board Size	155mm X 55mm

Revision History

Version	Date	Summary
v05	2013.03.19	Updates to reflect new features in firmware 113-08501-130
V06	2013.06.23	Corrected mistake in the description for waveform download frame structure.